

MODELING AND SIMULATION OF THREE PHASE MATRIX CONVERTER USING LABVIEW

C. Ponmani.

Assistant Professor, Government College of Engineering,
Tirunelveli, India.
ponmani@gcetly.ac.in

Abstract: Matrix converter is well known for its advantages over two stage ac-dc-ac converters. Though matrix converter is very popular, due to the limitations like commutation of bidirectional switches and generation of many number of switching pulses, the market penetration is very slow. For a three phase direct matrix converter eighteen number of gate pulses are to be produced and hence FPGA or Digital Signal Processor interfaced with Programmable Logic Devices is mandatory and hence implementation becomes difficult. In this paper modeling and simulation of three phase direct matrix converter using LabVIEW software is presented. LabVIEW provides visual modeling platform and software tools that can be directly integrated to FPGA for the real time implementation of modulation methods, voltage and current measurement based commutation logics to produce eighteen number of gate pulses to the bidirectional switches of matrix converter and advanced control algorithms.

Keywords: Matrix Converter, Modeling, Simulation, LabVIEW software.

I. INTRODUCTION

Matrix converter is a direct AC-AC single stage power converter. The theory, performance and analysis of matrix converter as a static power frequency converter was proposed in [1]. The topology and Venturini modulation algorithm for matrix converter with sinusoidal input and output waveforms is presented in [2-5]. Review of matrix converter technology [6] and a detailed review of different topologies of matrix converter is presented in [7]. Industrial applications of matrix converter are discussed in [8-9]. Space vector modulation method for matrix converter is presented in [10-12]. Carrier based modulation techniques and sampling issues are presented in [13-14]. A detailed review of different modulation methods are presented in [15]. The disturbance in the input voltage if any will directly appear in the load side as there is no energy storage elements in the matrix converter. Compensation strategies of matrix converter under input voltage disturbances are presented in [16-17]. Mathematical modeling, simulation and analysis of matrix converter using Matlab software is presented in [18-21]. In this paper modeling and simulation of matrix converter using LabVIEW software is presented. LabVIEW modules can be directly integrated to FPGA boards to produce eighteen number of gate pulses for the implementation of matrix converter in real time applications.

II. MODELING OF THREE-TO-THREE-PHASE DIRECT MATRIX CONVERTER

Conventional AC-AC frequency converters are two stage (AC-DC-AC) converters but the matrix converter is a direct (AC-AC) frequency converter with very less reactive elements for input and output filters and not for energy storage. The general power circuit topology of a three-to-three-phase direct matrix converter is illustrated in Figure 1. There are three legs, where each leg has three bidirectional power switches with antiparallel connected insulated-gate bipolar transistors (IGBTs) and diodes. In matrix converter, the input is considered is a voltage source and, inductive nature of the load in most cases, the output terminals are considered as current sources. The desired

amplitude and frequency of output voltage, are achieved through piecewise sampling of the input voltages without the need of energy storage elements as in conventional frequency converters. The instantaneous value of the input power is always equal to the instantaneous value of the output power in an ideal direct frequency converter because of the absence of energy storage elements.

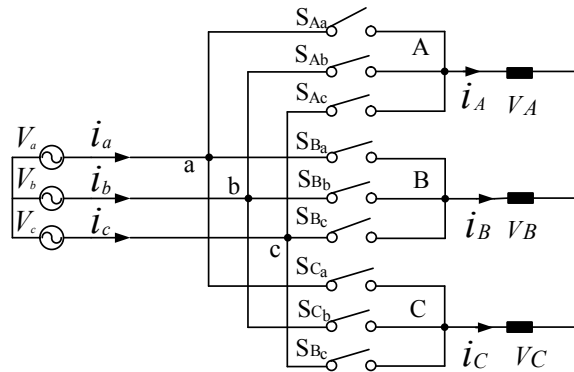

Figure.1 Topology of three-to-three-phase direct matrix converter

The input and the output voltages of three –to-three-phase direct matrix converter can be expressed as vectors defined as follows.

Let $[V_i]$ is the vector of the input voltages represented as,

$$[V_i] = V_{im} \begin{bmatrix} \cos \omega_i t \\ \cos(\omega_i t - 2\pi/3) \\ \cos(\omega_i t - 4\pi/3) \end{bmatrix} \quad (1)$$

and $[V_o]$ is the vector of output voltages represented as,

$$[V_o] = V_{om} \begin{bmatrix} \cos \omega_0 t \\ \cos \omega_0 t - 2\pi/3 \\ \cos \omega_0 t - 4\pi/3 \end{bmatrix} \quad (2)$$

The problem consists in finding a matrix M, known as the modulation matrix, such that

$$[V_o]=[M] \cdot [V_i] \quad (3)$$

While, input current $[I_i]$ and output current are related as

$$[I_i]=[M]^T [I_o] \quad (4)$$

where $[M]^T$ represents the transposed matrix of $[M]$.

III. VENTURINI CONTROL ALGORITHM

Basic configuration of Direct Matrix Converter without dc link energy storage elements and a conversion technique named as Venturini Algorithm to produce a variable frequency sine wave output from the fixed frequency sine wave input was proposed by Venturini [2], with a limitation on voltage transfer ratio of 0.5 and a restriction in the input power factor control. An enhanced modulation method for direct Matrix Converter which can produce optimum voltage transfer ratio of 0.866 was presented by Alesina and Venturini [4]. In enhanced modulation

method the voltage transfer ratio is raised to 0.866 by injecting third-harmonic of the input frequency to the input-phase voltages and by subtracting the third harmonic of the output frequency from the desired output phase voltages. Fig.2 shows the LabVIEW simulation result obtained for the envelope of input and output voltage with 86.6 % voltage transfer ratio for three-to-three phase direct matrix converter. The time axis is floating point representation in Fig.2.

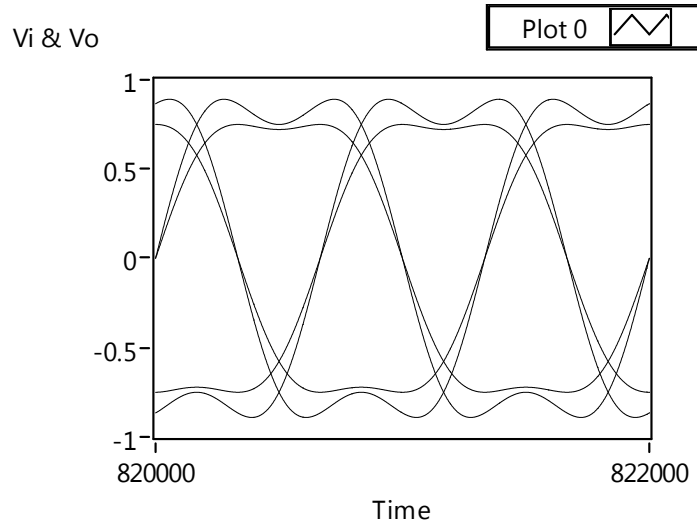

Figure.2. Envelope of Input and output voltages for 86.6 % voltage transfer ratio in three-to-three phase direct matrix converter

In Venturini enhanced modulation method for direct Matrix Converter [24], for a set of three-phase input voltages with constant amplitude and frequency f_i , this method calculates the duty cycle of each of the nine bidirectional switches. The result when implemented allows the generation of a set of three-phase output voltages by sequential piecewise sampling of the input waveforms. The three phase output voltage thus obtained should desirably track a predefined reference waveform and when a three phase load is connected, the input currents of magnitude I_i and angular frequency ω_i should be in phase with the input voltages. To attain the above features, a mathematical approach is employed [22]. The relationship between the input and output voltages and that of the output and input currents are written respectively as:

$$\begin{bmatrix} V_{oa}(t) \\ V_{ob}(t) \\ V_{oc}(t) \end{bmatrix} = \begin{bmatrix} m_{aA} & m_{aB} & m_{aC} \\ m_{bA} & m_{bB} & m_{bC} \\ m_{cA} & m_{cB} & m_{cC} \end{bmatrix} \times \begin{bmatrix} V_{iA} \\ V_{iB} \\ V_{iC} \end{bmatrix} \tag{7}$$

where $m_{ij}(t)$ represents the duty cycles of a switch connecting output phase i to input phase j within one switching sample interval. At any time t , $0 \leq m_{ij}(t) \leq 1$ and

$$\sum_{j=A}^C m_{ij} = 1, \quad (i=a,b,c) \text{ and } (j=A,B,C) \tag{8}$$

To obtain maximum output to input voltage ratio, a reference three phase voltage is defined as

$$\begin{bmatrix} V_{oa}(t) \\ V_{ob}(t) \\ V_{oc}(t) \end{bmatrix} = V_{om} \begin{bmatrix} \cos(\omega_o t) \\ \cos(\omega_o t - \frac{2\pi}{3}) \\ \cos(\omega_o t - \frac{4\pi}{3}) \end{bmatrix} - \frac{V_{om}}{6} \begin{bmatrix} \cos(3\omega_o t) \\ \cos(3\omega_o t) \\ \cos(3\omega_o t) \end{bmatrix} + \frac{V_{im}}{4} \begin{bmatrix} \cos(3\omega_i t) \\ \cos(3\omega_i t) \\ \cos(3\omega_i t) \end{bmatrix} \tag{9}$$

where V_{om} and V_{im} are the magnitudes of output and input fundamental voltages, respectively, and ω_o and ω_i corresponds to the output and input angular frequencies. When $V_{om} \leq \sqrt{\frac{2}{3}} V_{in}$, the functional solutions for the duty cycles $m_{ij}(t)$ can be determined and the general formula is given as,

$$m_{ij} = \frac{1}{3} \left\{ 1 + 2Q \cos(\omega_i t - \frac{2(j-1)\pi}{3}) \left[\cos(\omega_o t - \frac{2(i-1)\pi}{3}) - \frac{1}{6} \cos(3\omega_o t) + \frac{1}{2\sqrt{3}} \cos(3\omega_i t) \right] - \frac{2Q}{3\sqrt{3}} \left[\cos(4\omega_i t - \frac{2(j-1)\pi}{3}) - \cos(2\omega_i t - \frac{2(1-j)\pi}{3}) \right] \right\} \tag{10}$$

where $i, j = 1, 2, 3$ and $Q = V_{om} / V_{im}$. Commutation of $m_{ij}(t)$ is carried out at a sample frequency f_s which also defines the converter switching frequency [23].

IV. RESULTS AND DISCUSSION

Mathematical modeling of three phase matrix converter with Venturini modulation algorithm is performed in LabVIEW software. The validity of the proposed algorithm using Venturini enhanced approach for three phase matrix converter is verified through modeling and simulation result analysis. The maximum value of input voltage is 1 pu and input frequency is 50 Hz with a switching frequency of 5 kHz is taken in LabVIEW simulation. In LabVIEW the time format is in floating point representation. The simulation results obtained for line to line output voltages of all the three phases with different output frequencies using LabVIEW are shown in figures (3) – (5). The simulation results obtained for three phase output voltages of all the three phases with different output frequencies using LabVIEW are shown in figures (6) – (8).

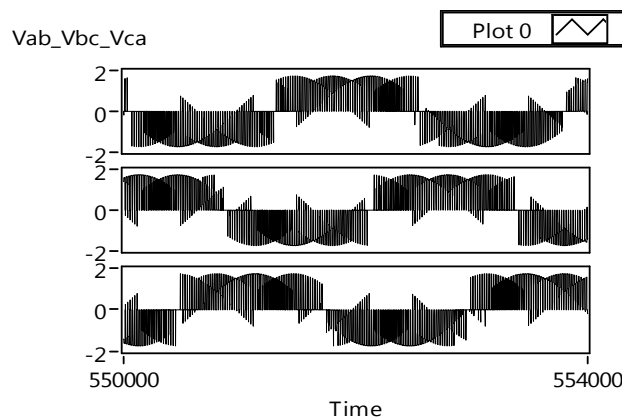

Figure.3 Line to line voltages with input and output frequencies of 50 and 40 Hz

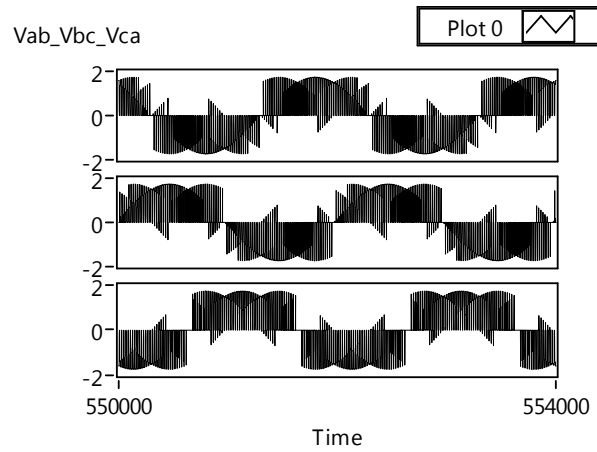

Figure.4 Line to line voltages with input and output frequencies of 50 and 50 Hz

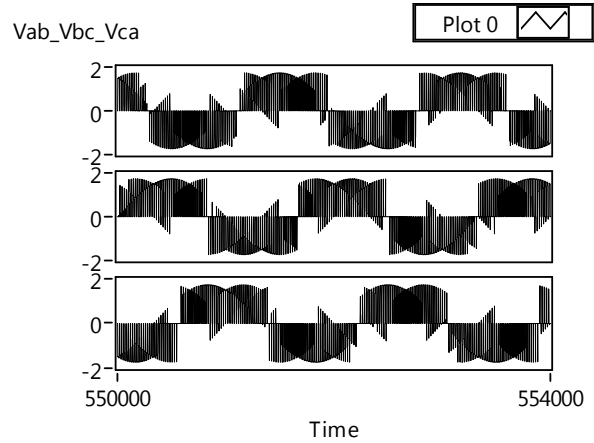

Figure.5 Line to line voltages with input and output frequencies of 50 and 60 Hz

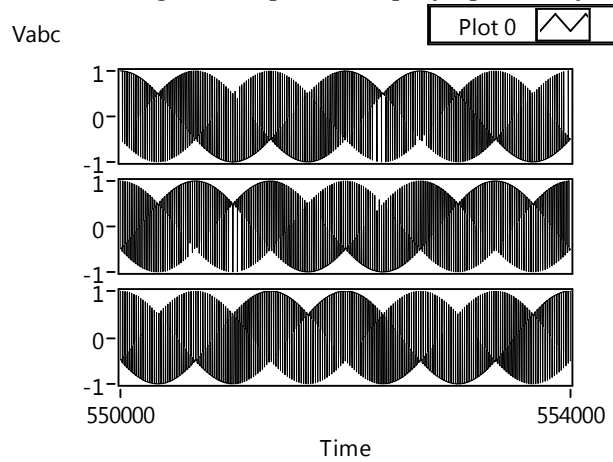

Figure.6 Phase voltages with input and output frequencies of 50 and 40 Hz

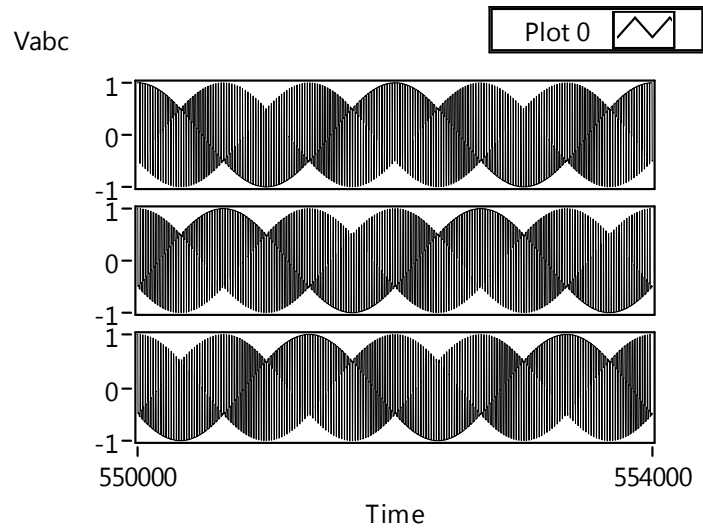

Figure.7 Phase voltages with input and output frequencies of 50 and 50 Hz

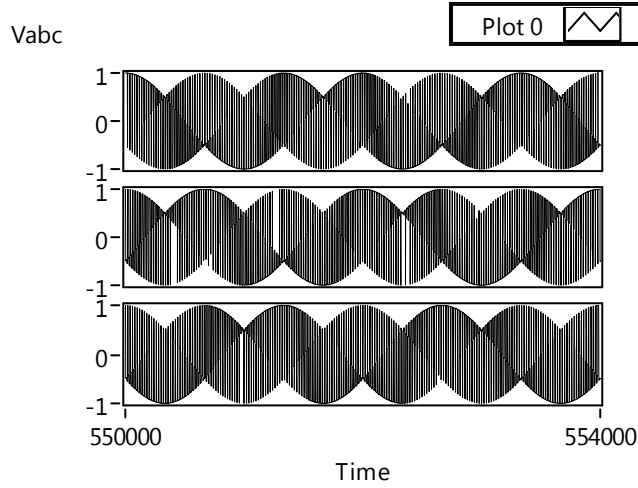

Figure.8 Phase voltages with input and output frequencies of 50 and 60 Hz

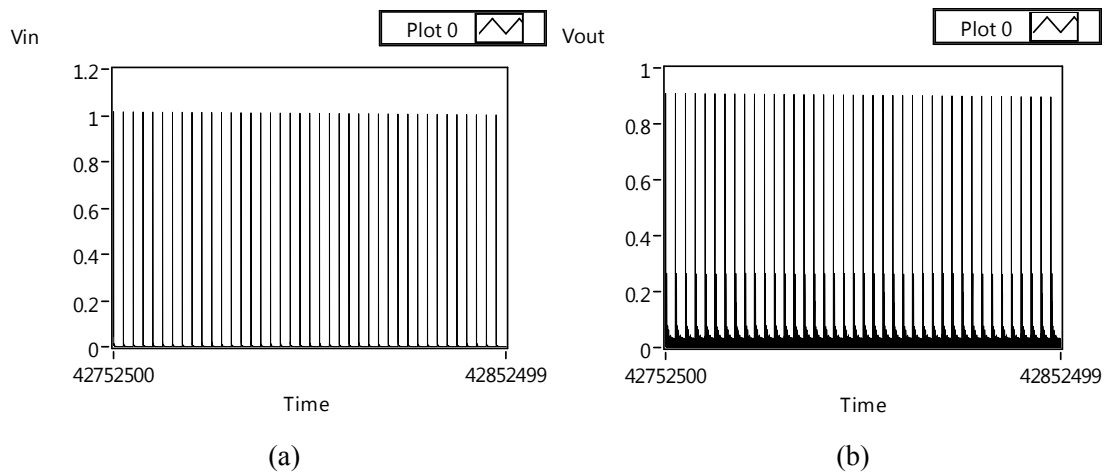

Figure.9. Magnitudes of amplitude spectrum (a) Input voltage (b) Output voltage

The amplitude and phase spectrum block of LabVIEW software is used to verify the voltage transfer ratio of three-to-three phase matrix converter using the proposed algorithm. The maximum value of input voltage is 1 pu. An output voltage magnitude of 0.866 pu is obtained for three-to-three phase matrix converter as shown in figure 9. Hence the maximum input to output voltage transfer ratio of 86.6% for three-to-three phase matrix converter using the proposed algorithm is validated. This model can be directly integrated to LabVIEW-FPGA modules through LabVIEW software to produce eighteen number of gate pulses for the implementation of matrix converter in real time applications with commutation algorithm.

V. CONCLUSION

In this paper mathematical modeling of Venturini modulation technique which is less complex to implement than the Space Vector Modulation technique of comparable performance is realized using LabVIEW software program for three-to-five phase matrix converter. The maximum voltage transfer ratio of 86.6% for three-to-three phase matrix converter is validated through the result. Implementation of the proposed algorithm with commutation and control techniques using LabVIEW-FPGA is the future work.

ACKNOWLEDGMENTS

This work was carried out in LabVIEW using MODROBS Project titled Modernization of Power Electronics and Drives Laboratory under AICTE Project - 8024/RIFD/MOD-076/2011-12.

REFERENCES

- [1] L. Gyugyi, B.R. Pelly (1976), "Static Power Frequency Changers. Theory, performance and applications," ISBN 0-471-678000-7, 442 pages, John Wiley & Sons, USA.
- [2] Venturini, M (1980), *A new sine wave in, sine wave out, conversion technique eliminates reactive elements*, (Proceedings of Powercon 7, San Diego,CA, pp. E3-1-E3-15.
- [3] Alesina, A. and Venturini, M (1981), "Solid-state power conversion: a Fourier analysis approach to generalized transformer synthesis," IEEE Transactions on Circuits System, vol. CAS-28, pp. 319-330.
- [4] Alesina, A. and Venturini, M. (1989), "Analysis and Design of Optimum-Amplitude Nine-Switch Direct AC-AC Converters", IEEE Transactions on Power Electronics, Vol. 4, no. 1, pp. 101-112.
- [5] P.D. Ziogas, S.I. Khan, and M.H. Rashid (1985), "Some Improved Forced Commutated Cyclo converters Structures", IEEE Transactions on Industry Applications, vol. IA-21, No 5, pp. 1242-1253.
- [6] Wheeler, P.W.; Rodriguez, J.; Clare, J.C.; Empringham, L.; Weinstein(2002), A., "Matrix converters: a technology review", IEEE Transactions on Industrial Electronics, vol. 49 , issue. 2, pp. 276 – 288.
- [7] Kolar, J.W., Friedli, T., Rodriguez, J., Wheeler, P.W. (2011), "Review of Three-Phase PWM AC-AC Converter Topologies", IEEE Transactions on Industrial Electronics, vol. 58 , issue.11, pp. 4988 – 5006.
- [8] Aziz Boukadoum , Tahar Bahi , Youcef Soufi , Abba Bouguerne , Sofiane Oudina, (2015), "Improvement of output current waveforms using SVM technique and fuzzy logic controller for matrix converter", COMPEL - The international journal for computation and mathematics in electrical and electronic engineering, Volume: 34 Issue: 6.
- [9] Igor Ye. Korotyeyev, Zbigniew Fedyczak (2009), "Steady and transient states modelling methods of matrix-reactance frequency converter with buck-boost topology ", COMPEL - The international journal for computation and mathematics in electrical and electronic engineering, Volume: 28 Issue: 3.
- [10] Senthilkumaran Mahadevan , Siddharth Raju , Ranganath Muthu (2013), "Elimination of common mode voltage using phase shifted dual source matrix converter with improved modulation index", COMPEL - The international journal for computation and mathematics in electrical and electronic engineering, Volume: 32 Issue: 6.
- [11] Casadei, D.; Serra, G.; Tani, A.; Zarri, L. (2002), "Matrix converter modulation strategies: a new general approach based on space-vector representation of the switch states" IEEE Transactions on Industrial Electronics, vol. 49 , issue: 2, pp. 370 – 381.

- [12] Fang Gao and Iravani, MR. (2007), "Dynamic Model of a Space Vector Modulated Matrix Converter", IEEE Transactions on Power Delivery, vol. 22, issue: 3, pp. 1696 – 1705.
- [13] Young-Doo Yoon; Seung-Ki Sul(2006), "Carrier-Based Modulation Technique for Matrix Converter", IEEE Transactions on Power Electronics, vol. 21 , Issue: 6, pp. 1691 – 1703.
- [14] Poh Chiang Loh; Runjie Rong; Blaabjerg, F. (2009), Peng Wang Digital Carrier Modulation and Sampling Issues of Matrix Converters", IEEE Transactions on Power Electronics, vol. 24, issue: 7, pp. 1690 – 1700.
- [15] Rodriguez, J., Rivera, M., Kolar, J.W. and Wheeler, P.W. (2012) ,"A Review of Control and Modulation Methods for Matrix Converters", IEEE Transactions on Industrial Electronics, vol. 59, issue. 1, pp. 58 – 70.
- [16] Sato, I.; Itoh, J.; Ohguchi, H.; Odaka, A.; Mine, H. (2007), An Improvement Method of Matrix Converter Drives Under Input Voltage Disturbances", IEEE Transactions on Power Electronics, vol. 22 , pp. 132 – 138.
- [17] C. Ponmani, M. Rajaram (2013), " Compensation Strategy of matrix converter fed induction motor drive under input voltage and load disturbances using internal model control", International Journal of Electrical Power and Energy Systems, issue 44, pp.43-51.
- [18] Imayavaramban, A.V.Krishnachaithanya and B.G.Fernandes (2006) ,"Analysis and Mathematical Modelling of Matrix Converter for adjustable speed AC Drives", Power System Conference and Exposition, PSCE'06, 1113-1120.
- [19] H. Altun and S. Sunter(2003), "Matrix converter induction motor drive: modeling, simulation and control", Electrical Engineering, vol.86, pp.25–33.
- [20] C. Ponmani, M. Rajaram(2011), "Performance Analysis of Matrix Converter fed Induction Motor with different switching algorithms", International Journal of Electrical Engineering, Vol.4, No.6 pp.661-668.
- [21] C. Ponmani, M. Rajaram(2012), "Mathematical Modelling and Simulation of Advanced AC Drives with matrix Converter", International Journal of Modelling and Simulation, vol. 32, pp.24-32.
- [22] Azeddine Bendiabdellah, Ghanem Bachir(2006), "A Comparative Performance Study between A Matrix Converter and a Three-Level Inverter Fed Induction Motor" Acta Electrotechnica Et Informatica, No. 2, Vol. 6.
- [23] L.Zhang, C.Watthanasarm, W.Shepherd (1998), "Analysis and comparison of control techniques for ac – ac converter" IEE Proc-Electr. Power Appl. Vol 145.
- [24] Hamid A. Toliyat and Steven Campbell (2004), *DSP-based Electromechanical Motion Control* (CRC Press LLC) Chap.15.